

PRZED ROZPOCZĘCIEM MONTAŻU ZAPOZNAĆ SIĘ Z INSTRUKCJĄ

Narzędzia niezbędne do montażu (nie dostarczane przez producenta)

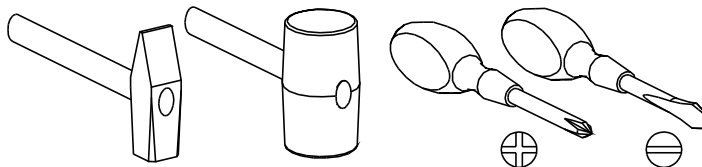
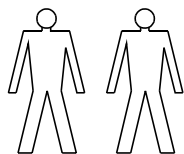

# LARSA

komoda 2d4s

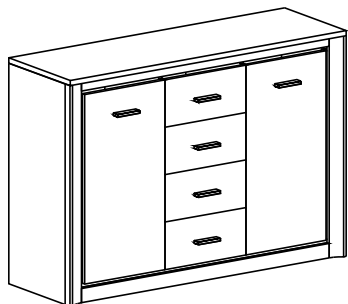

Nr	Nazwa elementu	Dł [mm]	Szer [mm]	Gr [mm]	Ilość	Kod	Paczka
1	biał	1370	432	22	1		2/2
2	listwa górna	1337	54	16	1		2/2
3	listwa górna przednia	1229	38	16	1		2/2
4	wieniec dolny	1337	397	16	1		2/2
5	bok lewy	931	400	16	1		1/2
6	przegroda lewa	854	397	16	1		1/2
7	przegroda prawa	854	397	16	1		1/2
8	bok prawy	931	400	16	1		1/2
9	front szuflady	394	200	16	4		1/2
10	HDF szuflady	356	346	2,5	4		2/2
11	tył szuflady	330	120	16	4		1/2
12	bok szuflady lewy	350	120	16	4		1/2
13	bok szuflady prawy	350	120	16	4		1/2
14	wieniec maty prawy	458	380	16	1		2/2
15	wieniec maty lewy	458	380	16	1		2/2
16	listwa pionowa	801	70	16	2		1/2
17	listwa MDF prawa	931	70	32	1		1/2
18	cokół tylny	1337	60	16	1		2/2
19	HDF ściany tylnej	882	476	2,5	2		2/2
20	HDF ściany tylnej	882	403	2,5	1		2/2
21	drzwi lewe	808	394	16	1		2/2
22	drzwi prawe	808	394	16	1		2/2
23	listwa MDF lewa	931	70	32	1		1/2
24	cokół przedni	1229	60	16	1		2/2

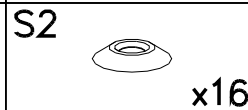
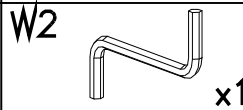
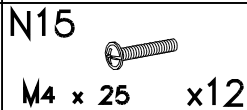
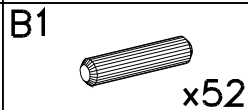
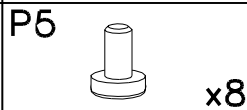
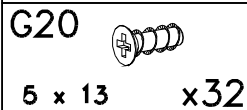
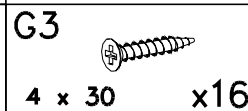
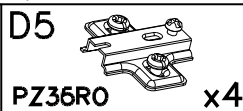
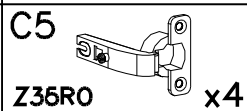
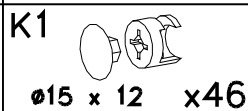
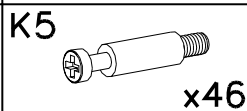
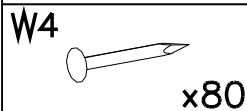
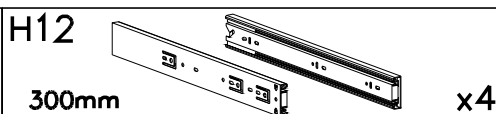
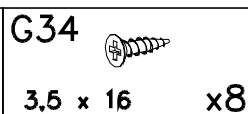
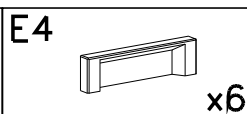
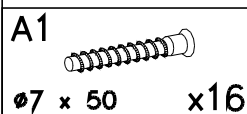
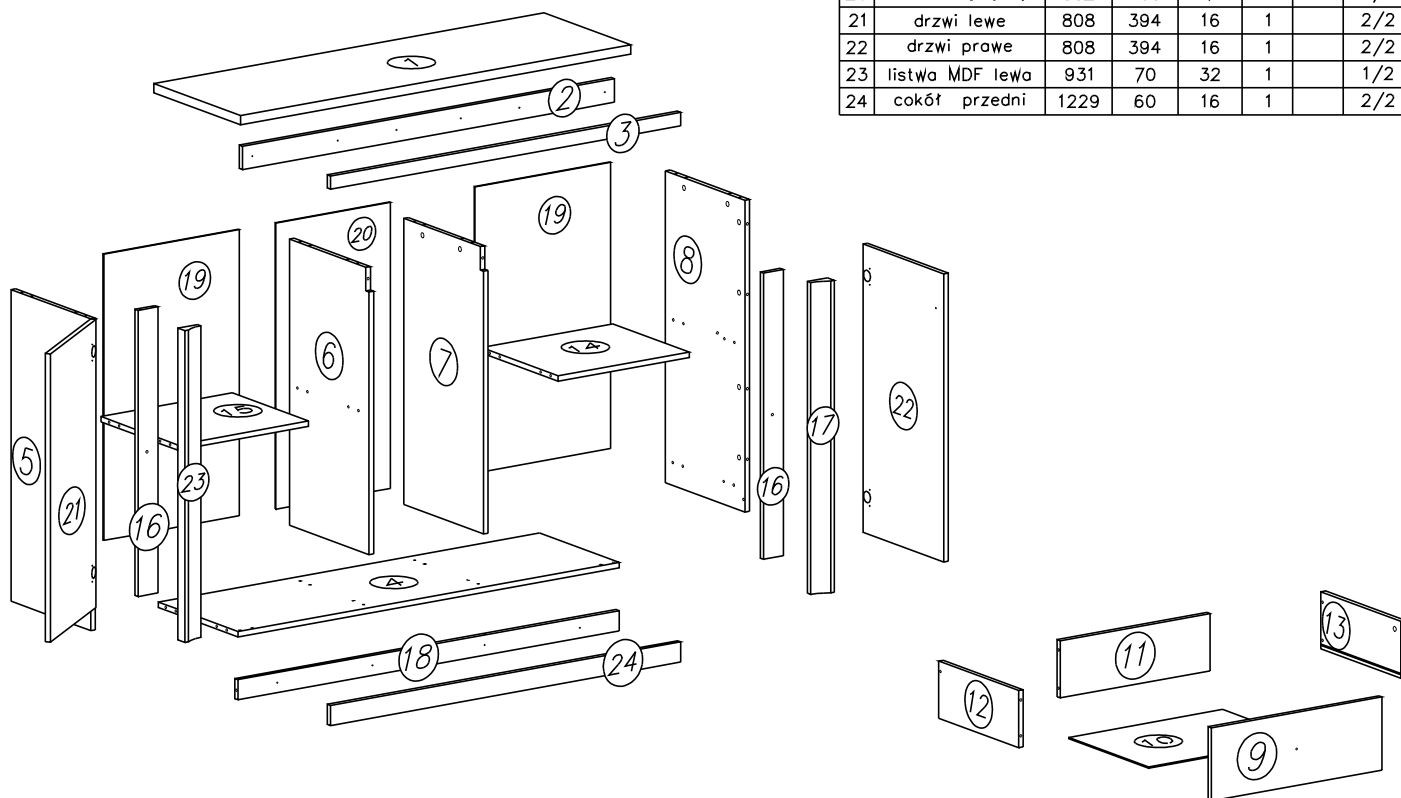

1

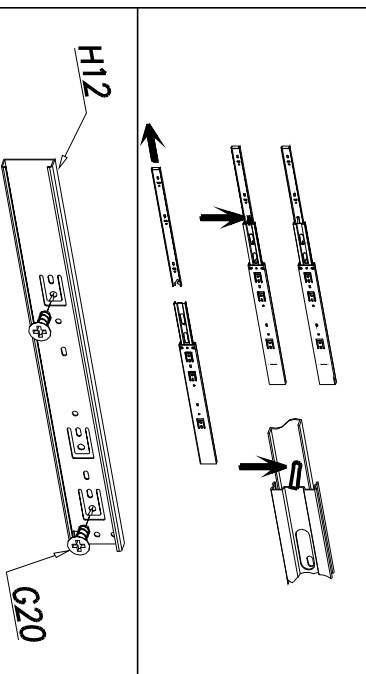
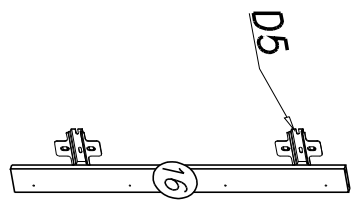
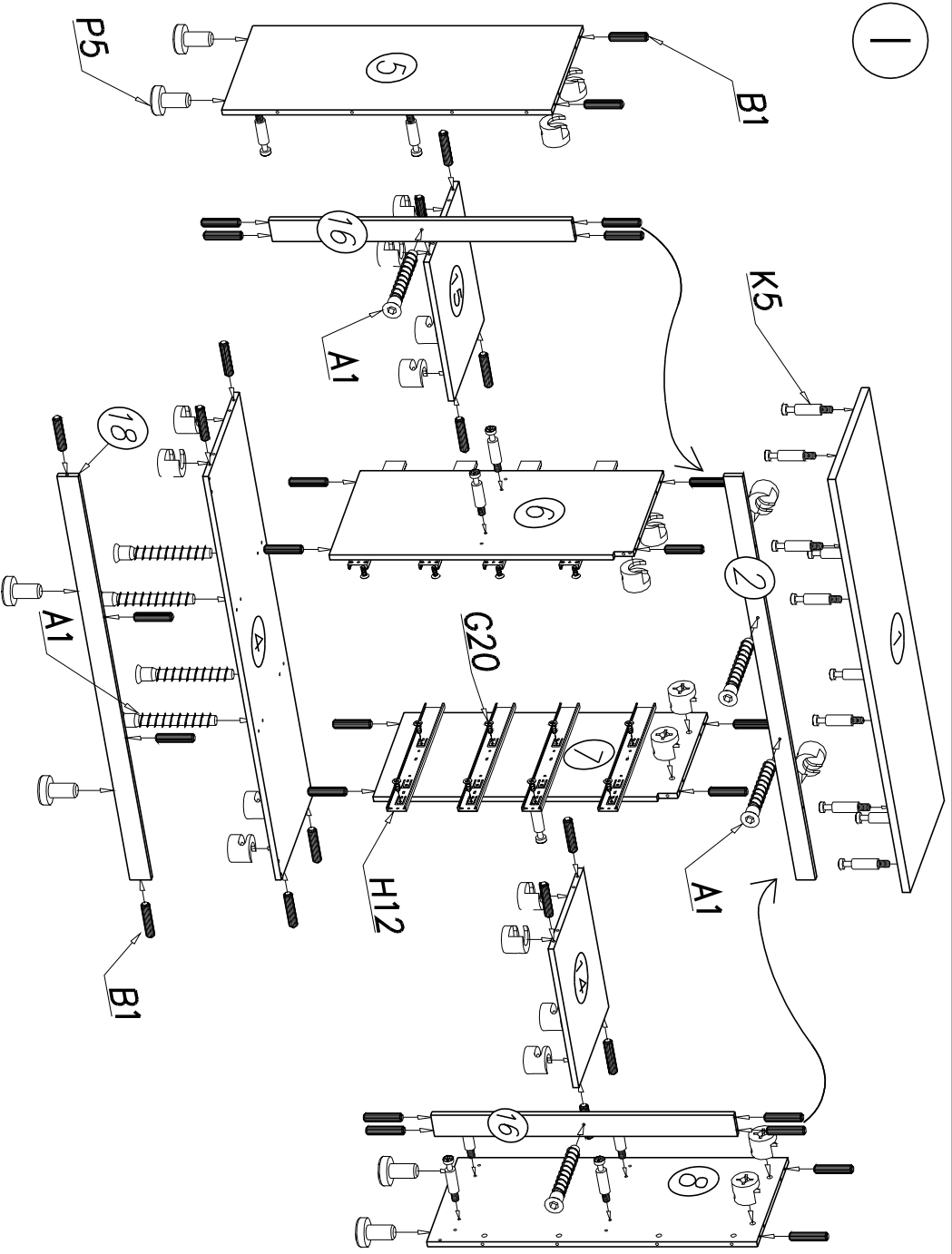

11

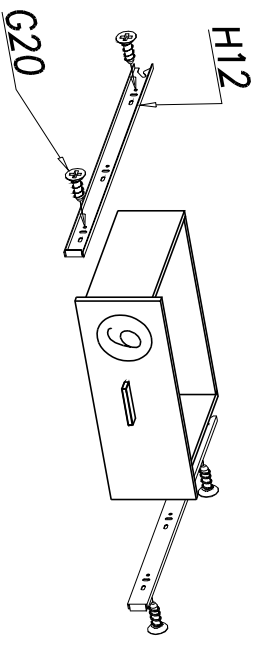
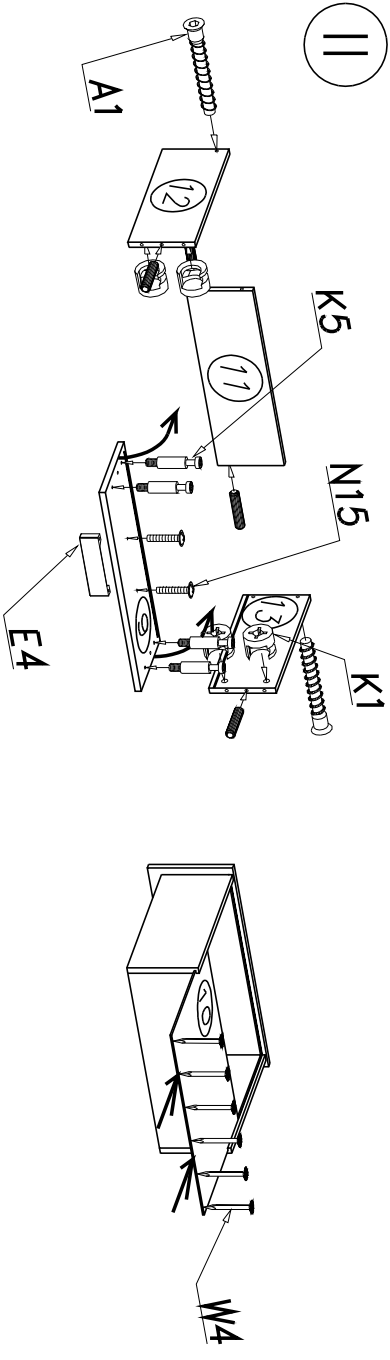

III

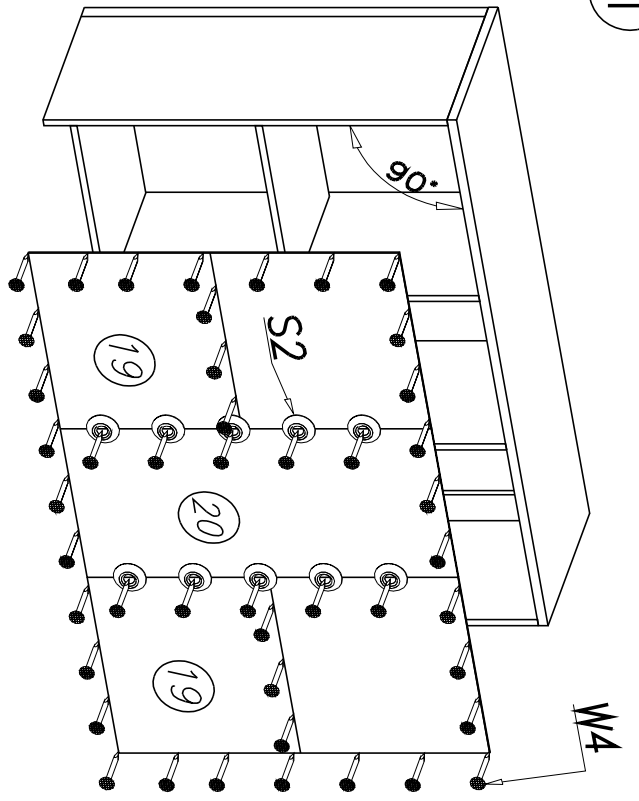

IV

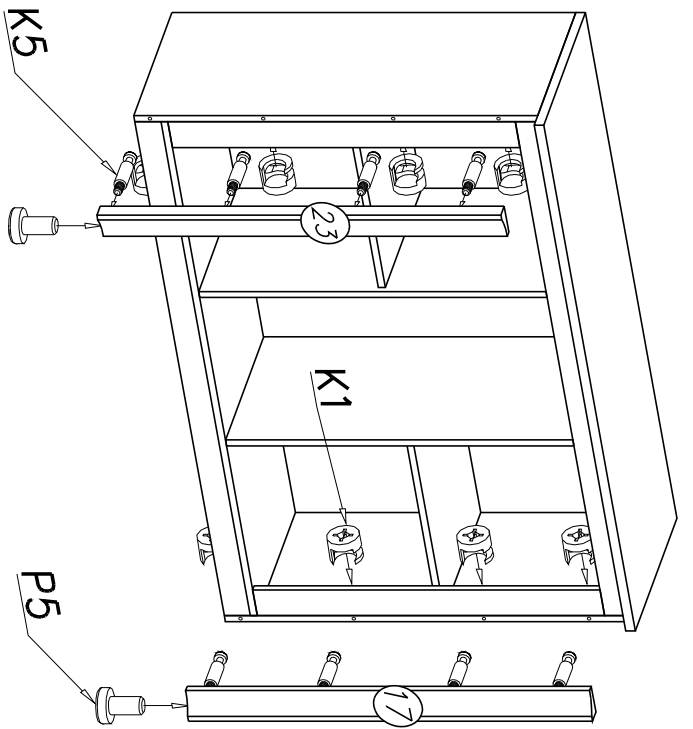

V

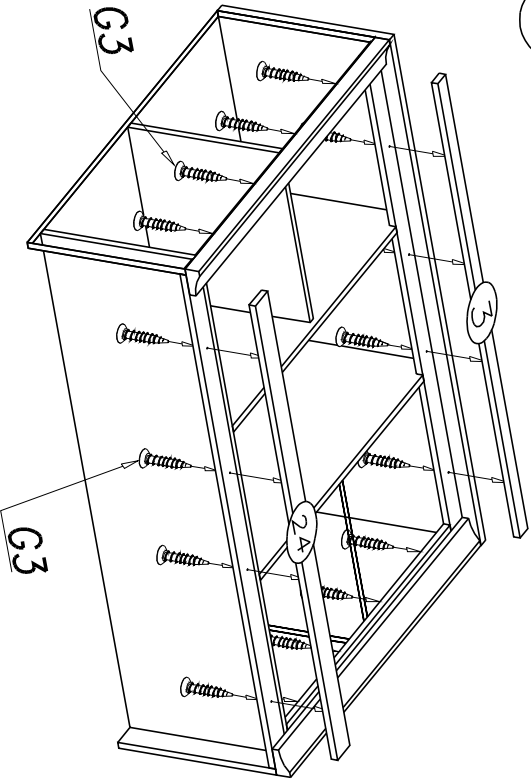

VI

